

23V03-30 VANITY COMBO INSTALLATION

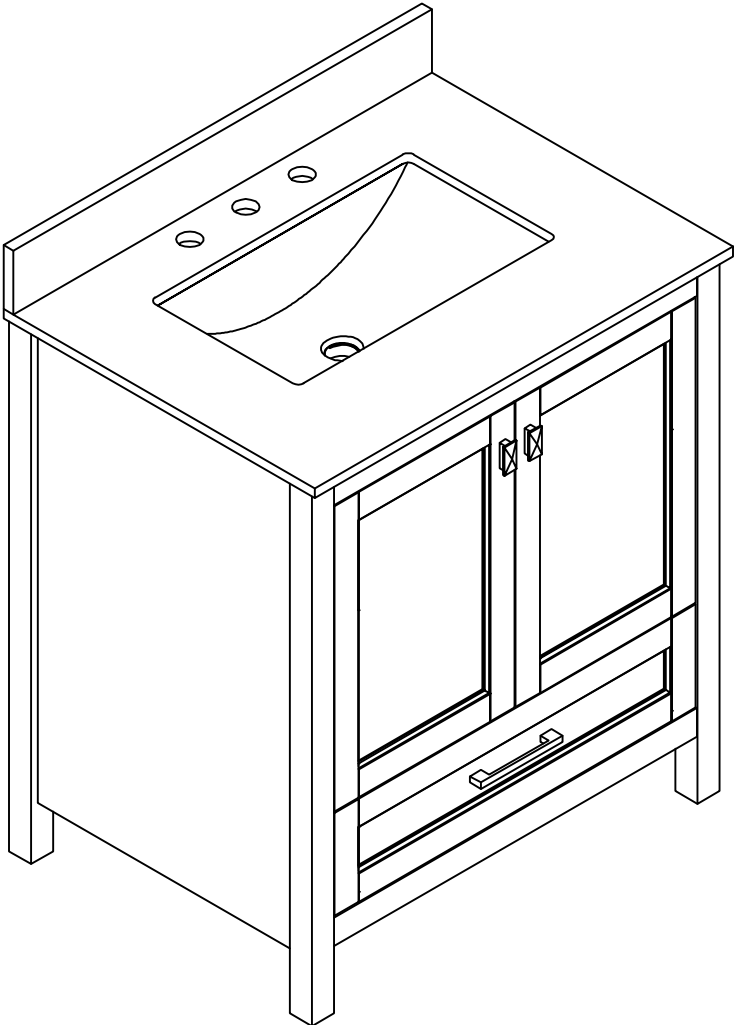

Leveling Your Vanity

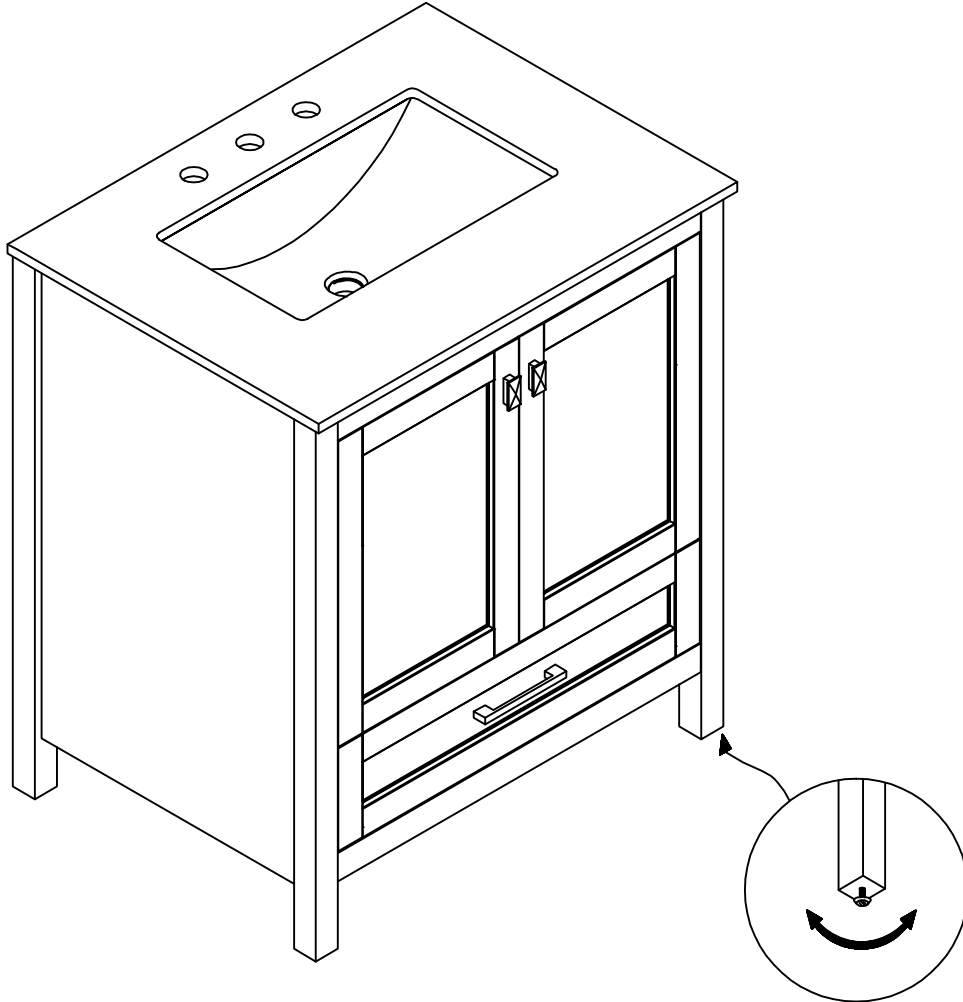

Use the Adjustable Leveler to level your Vanity

Adjusting the Doors

Make sure the door is in the correct position, make adjustments, if necessary.

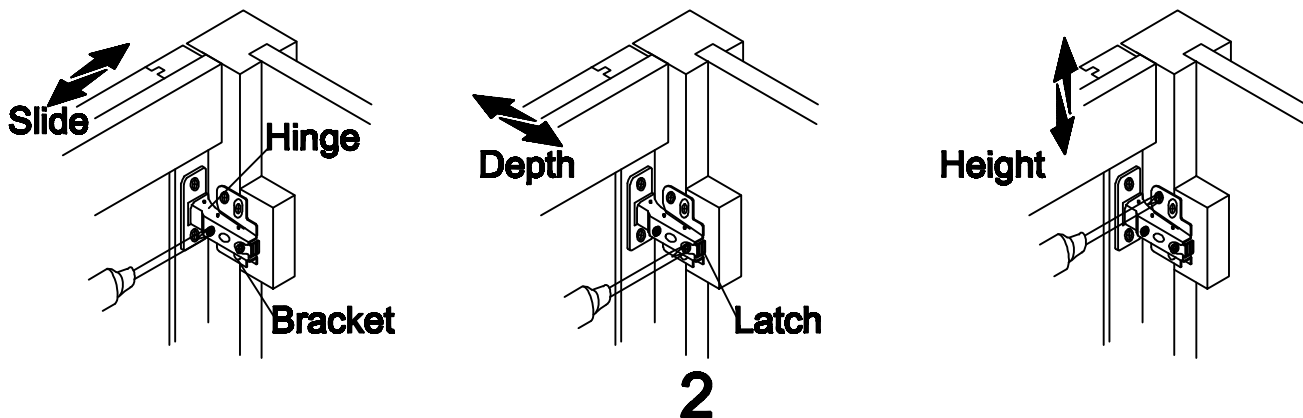

Adjusting the drawers

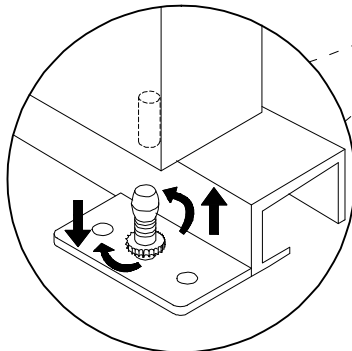
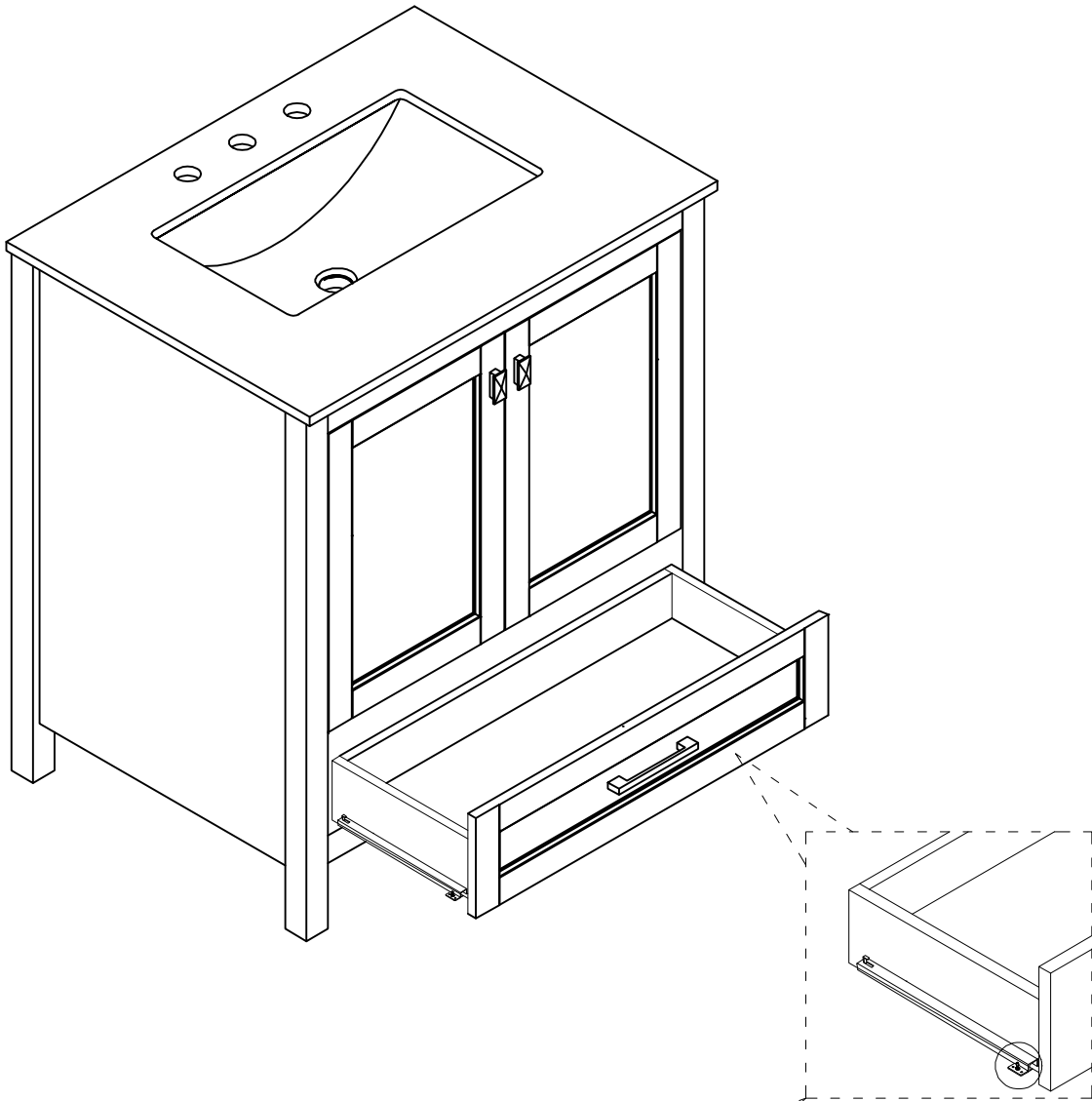

Adjust the drawers up and down

Secure the Vanity Top and Back Splash to the Vanity

1. Center the Back Splash on the Basin.
2. Let the weight of the Back Splash rest on the Vanity Top to adhere to the Caulk
3. Place a bead of caulk along the top of the Back Splash and Wall

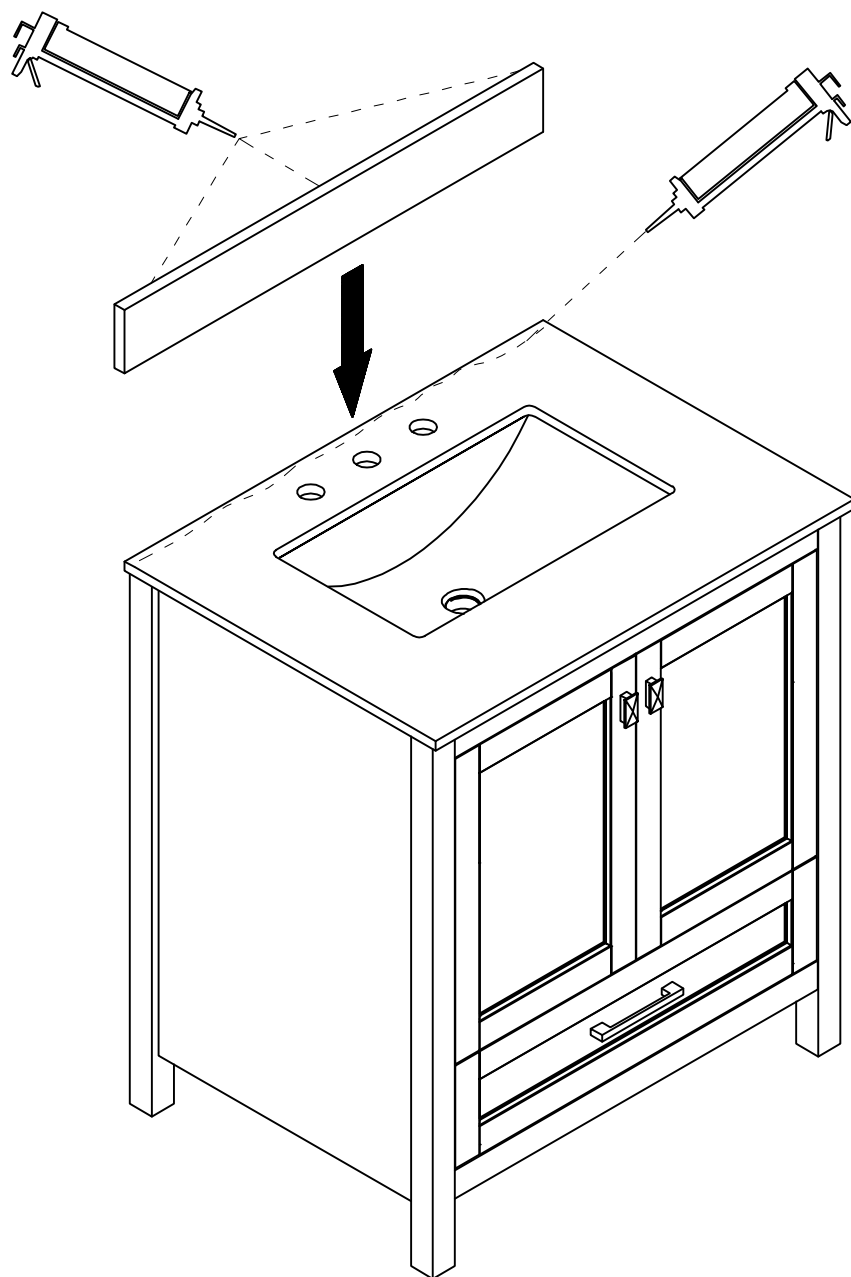

Let the Caulk set for 24 hours